

D

C

B

A

2

2

1

REFERENCIAS:

PL-01-001-001 TABLERO PLC-MAS
 PL-01-001-002 TABLERO PLC REMOTA 001
 PL-01-001-003 TABLERO PLC REMOTA 002

PL-TIPO-SECTOR-N°PLANO
 TIPO: 01 ELECTRICO
 TIPO: 02 MECANICO
 TIPO: 03 CIVIL
 TIPO: 04 COMUNICACIONES
 SECTOR: 01 MUELLE ALFONSINA STORNI MAS
 SECTOR: 02 MUELLE LUIS PIEDRA BUENA MLPB

▲					
▲					
▲	PARA APROBACION APPM - SE AGREGAN CONV	02/05/24	INGENNIA	JIG	FTI
▲	PARA APROBACION APPM	19/04/24	INGENNIA	JIG	FTI
REV.	TIPO DE MODIFICACION	FECHA	EJEC.	CONTR.	APROBO

	FECHA	NOMBRE	FIRMA
DIB.	19/04/24	JOG	
REV.	19/04/24	LMM	
APR.	19/04/24	JOG	
Esc.:			

MAS
 TOPOLOGIA
 RED DE CONTROL
 INGENIERIA DE DETALLE

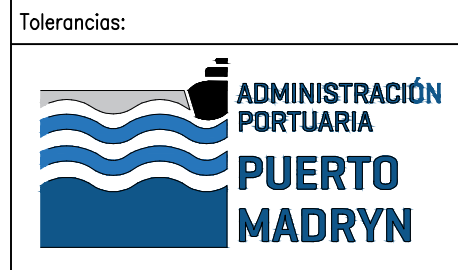

Tolerancias:		CAD N°	PL04001001	A3
		Plano N°	PL-04-001-001	Rev. 1

IDENTIFICACION CABLEADO:



RED UTP
 WCOMXXX UTP CAT5E
 PCUXXX PATCHCORD INTERNO UTP CAT5E

RED RS485
 RX.485.XX CABLE TRENSADO COMPENSADO
 TRAMO RED
 TABLERO REMOTA

X NRO. CORRELATIVO
 INTERCONEXION
 NN.X

NN NRO. HOJA
 X NRO. CORRELATIVO

PUESTA A TIERRA:

 PE PUESTA A TIERRA ELECTRICA
 PAT INST. PUESTA A TIERRA ELECTRONICA - SIN RUIDO

REV.	TIPO DE MODIFICACION	FECHA	EJEC.	CONTR.	APROBO	Sustituye a: -			CAD N° : PL04001001H 002		
						FECHA	NOMBRE	FIRMA	Hoja: 002	Sigue: 007	A3
						DIB. 15/04/24	JOG		Plano N° PL-04-001-001	Rev. A	
						REV. 15/04/24	LMM				
						APR. 15/04/24	JOG				

MAS
 TOPOLOGIA RED
 REFERENCIAS



H G F E D C B A

4

4

3

3

2

2

1

1

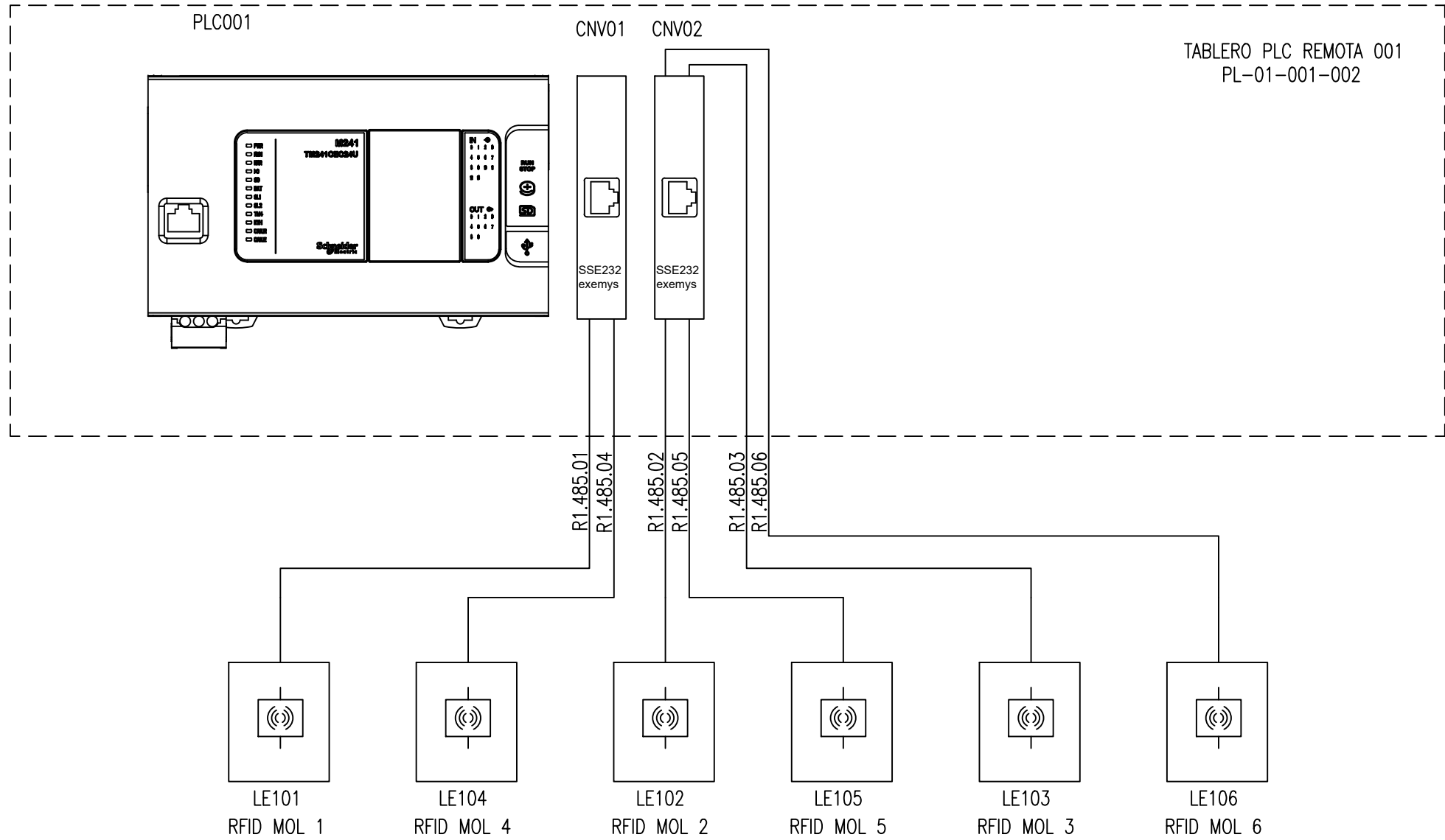

REV.	PARA CONSTRUCCIÓN	02/05/24	INGENIA	JIG	FTI	Sustituye a: -	CAD N° : PL04001001H 012			MAS TOPOLOGIA RED RS485 - PLC ET001					
	TIPO DE MODIFICACION	FECHA	EJEC.	CONTR.	APROBO	DIB.	FECHA	NOMBRE	FIRMA			Hoja: 012	Sigue: 013	A3	
							REV.	29/04/24	LMM				Plano N°		Rev.
							APR.	29/04/24	JOG				PL-04-001-001		A

I O L W D C M A

H G F E D C B A

4

3

2

1

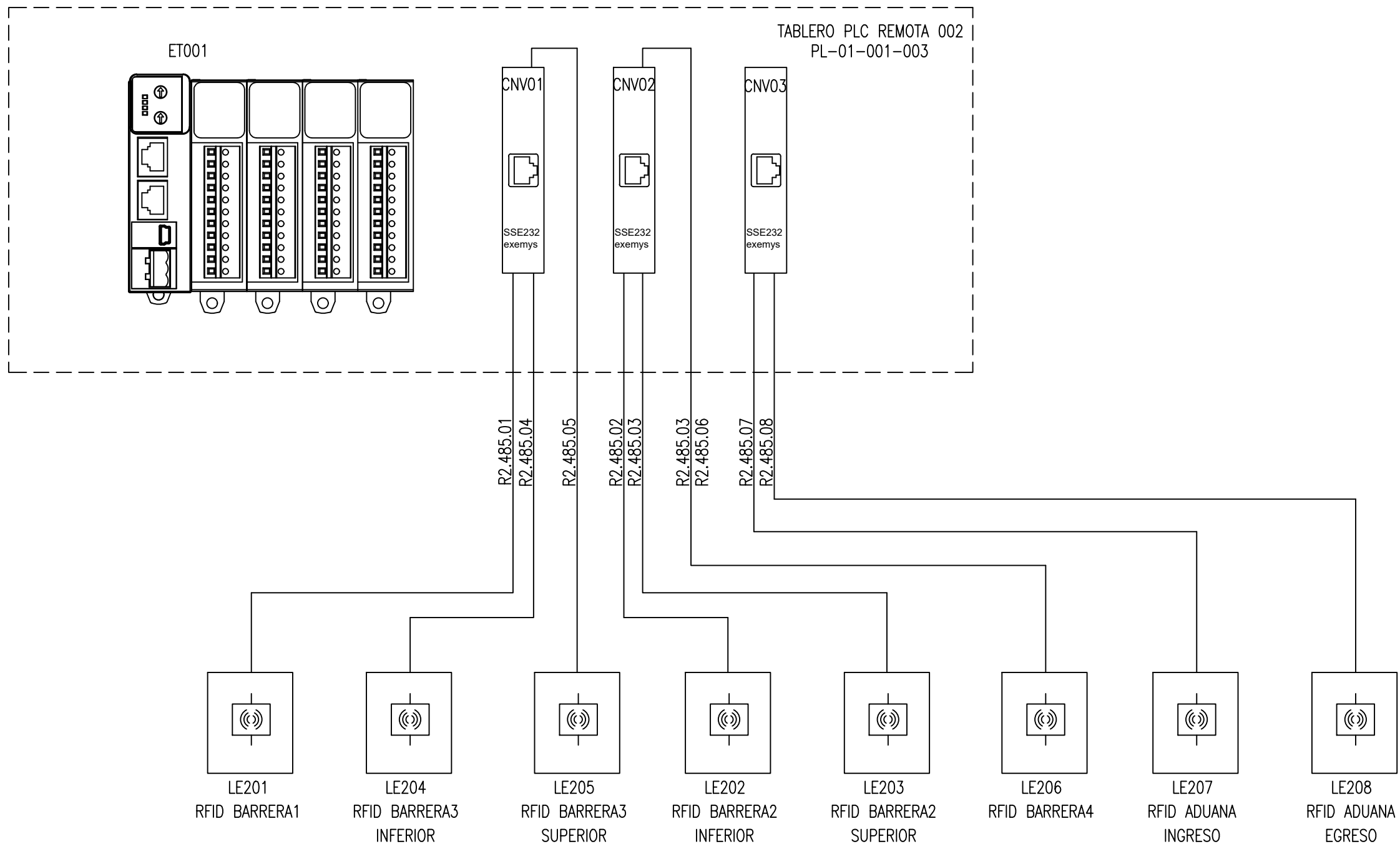

4

3

2

1

REV.	PARA CONSTRUCCIÓN	02/05/24	INGENIA	JIG	FTI	Sustituye a: -			CAD N° : PL04001001H 013			MAS TOPOLOGIA RED RS485 - PLC ET002		
						DIB.	29/04/24	JOG		Hoja: 013	Sigue: 015			A3
						REV.	29/04/24	LMM		Plano N°				Rev.
		TIPO DE MODIFICACION	FECHA	EJEC.	CONTR.	APROBO	APR.	29/04/24	JOG	PL-04-001-001				A

I O L W D C M A

